



2" metal blinds

installation & care instructions



thank you for purchasing from the shade store. simply follow our step-by-step instructions, and your beautiful new blinds will soon be enhancing your home or work space for many years to come.

getting started

carefully unpack your shades and check to make sure you have the following installation parts.

we recommend reading through these instructions before starting the installation.

- screws
- two mounting brackets
- a wand (if selected)
- valance

OPTIONAL*

- projection brackets
- auxiliary brackets (large shades)
- two hold down brackets with pins

*optional parts have been supplied but are seldom necessary for proper installation.

please note that your brackets must be securely attached to the mounting surface. if your screws do not hit wood studs you'll have to use a different fastener which can be found at any local hardware store.

INSTALLING YOUR 2" METAL BLINDS

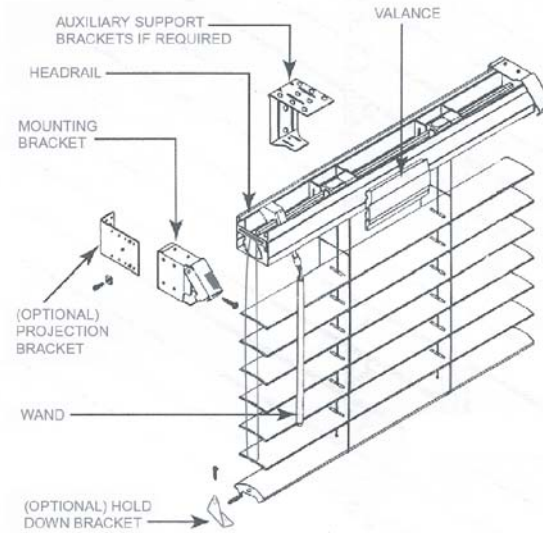

tools you will need

- drill with a 1/8" bit & a phillips bit
- flathead screwdriver
- metal tape measure

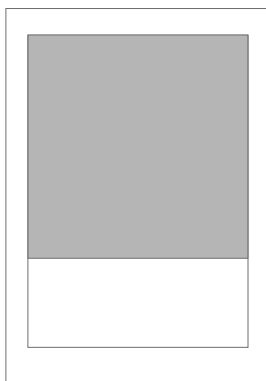

INSIDE MOUNT

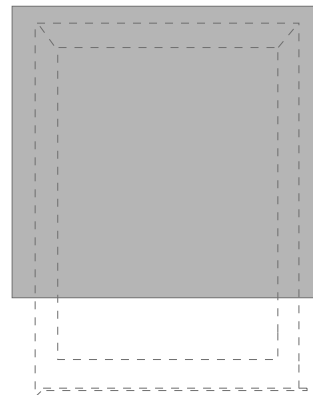

OUTSIDE MOUNT

for assistance, visit our website at www.theshadestore.com or contact customer service:
install@theshadestore.com or call 800.754.1455

1 installation instructions

unwrap the blind. do not untie cord at this time. hold the blind against the window to determine the proper placement. it will either fit inside the window casing (inside mount) or outside on the window casing or wall (outside mount). this will determine where and how your installation brackets should be attached.

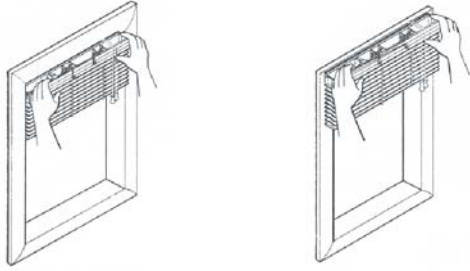

INSIDE MOUNT. make certain the headrail is level and clear of obstructions. make pencil marks 1/8" below the headrail on each end. the bottom of the installation brackets will be placed on these marks.

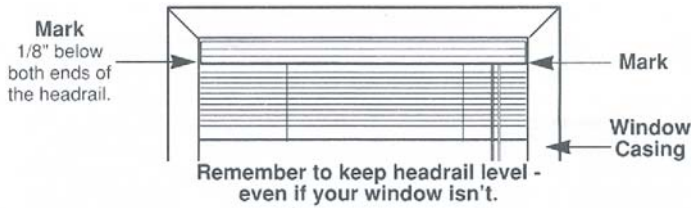

OUTSIDE MOUNT. hold the blind level and center against the window casing or wall. mark the casing/wall with a pencil just below the headrail on each end. also mark the window casing/wall 1/8" beyond the ends of the headrail. the installation brackets will be placed on these marks.

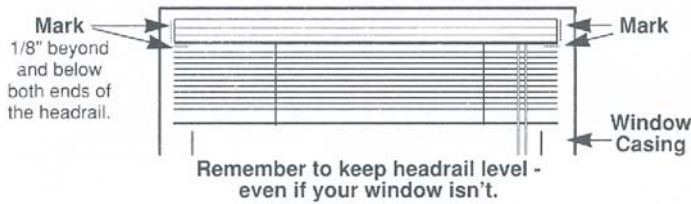

2 mounting installation brackets

the brackets may be mounted using two screws in several different orientations depending on your needs:

- a. inside the jambs (inside mount)
- b. to the outside of the window casing or wall (outside mount)
- c. overhead: either to the top inside of the window frame (inside mount) or to the ceiling (outside mount).

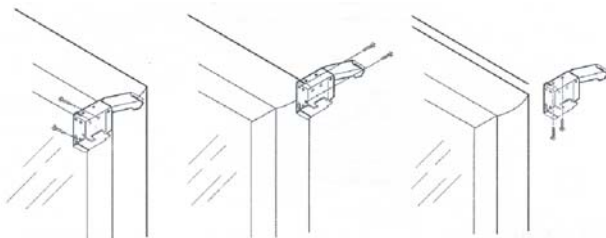

open the bracket's swivel cover with a screwdriver. hold the bracket against the mounting surface and align it with the pencil marks. using a pencil, mark the location of the two diagonal holes for the mounting screws. predrill marks with 1/8" drill bit. make sure to keep the screws at least 1/4" from the edge of the wood to prevent the wood from splitting. install brackets. * if additional projection is required see step 2A. if auxiliary support brackets have been supplied go to step 2B.

2A PROJECTION BRACKETS (optional) mount the projection bracket to the wall or window casing using the long wood screws or an alternative fastener appropriate to your mounting surface. attach the mounting brackets to the projection brackets using the screws and nuts provided.

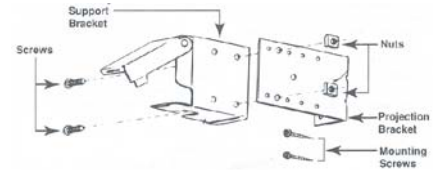

2B AUXILIARY SUPPORT BRACKETS (optional). if an auxiliary support bracket is included with your blind it should be placed in line with the installation brackets. the auxiliary support should not be in line vertically with the blind's cord or ladder as it may interfere with the blind's lifting and tilting mechanism.

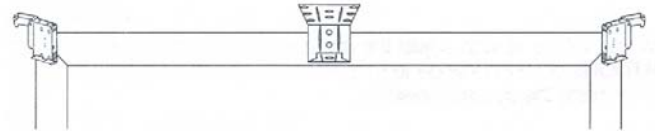

if projections brackets are being used, mount projection bracket to the wall or window casing and attach the auxiliary support using screw and nut.

3 headrail installation

with brackets installed insert the headrail into the mounting brackets.

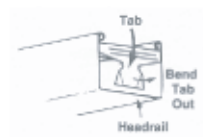
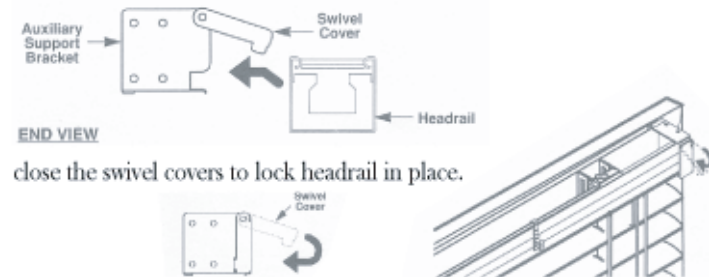

*if your blind is not fitting snugly left to right, open the mounting brackets, remove the headrail and pry out the tab at the end of the headrail with a screwdriver.

valance installation

if your blind was ordered as an outside mount, the valance is supplied with pre-mounted returns. no returns are included with an inside mount. simply attach valance clips to the back of the valance. position the valance on the headrail and snap into place.

wand attachment (if applicable)

attach the wand to hook and slide sleeve down to trap wand in place. you will now be able to adjust the angle of the slats by turning the wand.
CAUTION: do not continue to turn the wand after it starts to bind as this may damage the tilt mechanism.



hold down brackets (optional)

hold down brackets are used to keep the bottom of the blind from swaying. (typically used when shade is mounted on a door.) fully extend the blind. insert the brackets/pins into holes on both sides of bottom rail. mark the hole location where the screws are to be inserted. keep the holes at least 1/4" from the edge of the wood to avoid splitting. you may use a 1/16" drill bit. install pins in bottom of rail. install brackets.

safety

ATTACHING THE CORD CLEAT (STANDARD CONTROL): if you have small children, you should install the cord cleat to keep the control cords out of harm's way. simply mount the cord cleat to the wall or window frame next to the shade with the screws provided.



mount the cord cleat at a safe height, taking into account furniture or other objects upon which a child may climb. then, after each use of the shade, simply wrap the excess cord around the cleat. it's fast, easy and safe.

MOUNTING THE CORD GUIDE (CONTINUOUS CORD CONTROL):



if you have small children, you should install the cord guide to keep the cord out of harm's way. simply mount the cord guide on the side of the window frame if you have an inside mount or on the wall for outside mounts. do not apply tension to the cord control. the control should run freely through the cord guide

care and cleaning

if the shade is dusty, simply vacuum over it using an upholstery attachment. for cleaning soiled spots, we recommend contacting a professional cleaning company.

warranty

the shade store 2" metal blinds are covered by a limited lifetime warranty. this warranty covers any defects in materials or workmanship so long as the product is measured and installed according to instructions. every shade store window treatment is designed to provide trouble-free use. in the unlikely event that warranty services is ever needed, simply contact customer service at install@theshadestore.com or 800-754-1455 for assistance.

